

# Aquabot

## Owner's Manual

This Manual is for use with:

**Aquabot**

**Aquabot Turbo**

**Aquabot Turbo**

*Remote Control*

**Aquabot Turbo SOLO**

*Remote Control*

**Aquabot PLUS**

*Remote Control*

**Aquabot Ultra**

*Remote Control*

And other Aquabot models



**AQUAPRODUCTS**

# Aquabot Operating Features

The reference numbers below are used throughout this manual

Figure 1

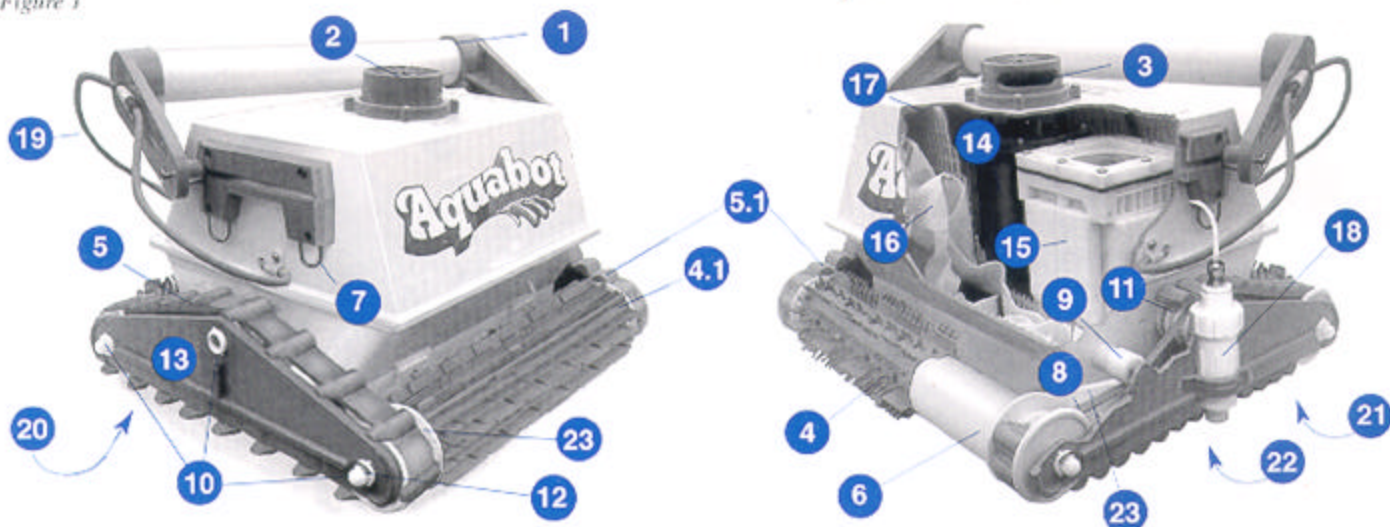

- |                              |                                |   |
|------------------------------|--------------------------------|---|
| 1.1 Floating Handle          | 1.8 Drive Belt                 | 1.16 Filter Bag                               |
| 1.2 Outlet Top               | 1.9 Stepped Sleeve Roller      | 1.17 Filter Screen                            |
| 1.3 Propeller                | 1.10 Bushing                   | 1.18 R/C Piston (Turbo R/C & Turbo Solo Only) |
| 1.4 Brushes*                 | 1.11 Pulley                    | 1.19 Floating Cable (see Fig 3)               |
| 1.4.1 Brushes - Turbo        | 1.12 Wheel Tube Retaining Ring | 1.20 Bottom Lid Assembly (see Fig. 2)         |
| 1.5 Drive Track - Turbo      | 1.13 Side Plate                | 1.21 Lock Tabs                                |
| 1.5.1 Drive Track - Standard | 1.14 Pump Motor                | 1.22 Small Roller                             |
| 1.6 Wheel Tube*              | 1.15 Drive Motor               | 1.23 G Drive Track Guide                      |
| 1.7 Handle Spring Lock       |                                |   |

\* Brushes and Wheel Tubes are split on Aquabot Plus R/C and Aquabot Ultra

## Bottom Lid/ Filter Bag Features

Figure 2

- 2.1 Bottom Lid
- 2.2 "W" Frame Bag Support
- 2.3 "H"-Float
- 2.4 Side Pocket Float
- 2.5 Intake Valve Flap Housings

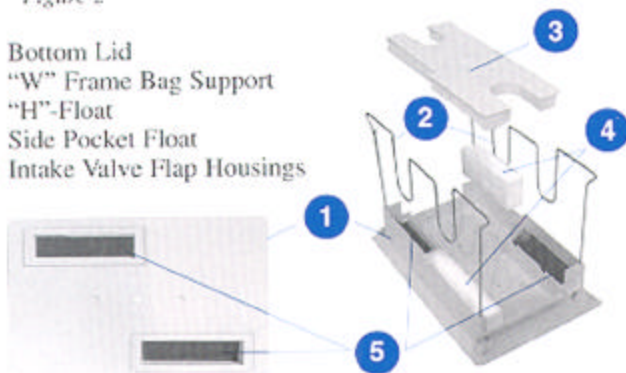

## Floating Cable Features

Figure 3

- 3.1 Floating Cable
- 3.2 Cable Plug (Aquabot & Turbo)
- 3.3 Cable Plug (Turbo R/C & Turbo SOLO)
- 3.4 Cable Plug (Plus R/C & Aquabot Ultra)
- 3.5 E-Z Swivel Cable Detangler



Figure 4  
Aquabot

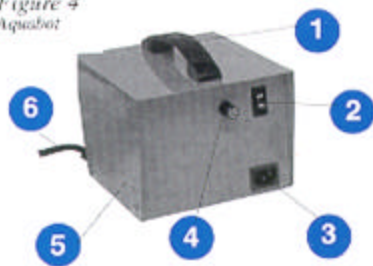

- 4.1 Power Supply Handle
- 4.2 Power Switch - On/Off
- 4.3 Floating Cable Socket (Aquabot & Aquabot Turbo)
- 4.4 Fuse Holder \*\*

## Power Supply Features

Figure 4A  
Aquabot Turbo

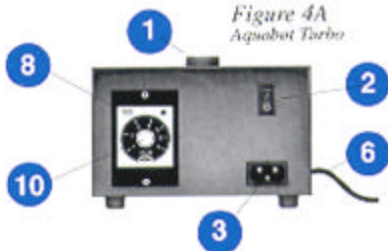

- 4.5 Power Supply Housing
- 4.6 Power Cable (115 VAC)
- 4.7 Antenna (Aquabot Plus R/C Aquabot Ultra)
- 4.8 Reset Switch (Aquabot Turbo)

Figure 4B  
Aquabot Turbo  
Remote Control



- 4.9 Floating Cable Socket (Remote Control Models)
- 4.10 Adjustable Timer (Aquabot Turbo)

\*\*Fuse Holder may be located on the back of the Power Supply in some cases

# Quick Start Instructions

## Preparing your new Aquabot to clean your pool is as easy as 1,2,3!

1. Lock the Floating Handle diagonally across the Aquabot's body.



2. Plug the Floating Cable into the Power Supply (the Power Supply should be placed at least 12 feet from the edge of the pool). Spread the Floating Cable evenly over the pool's surface.

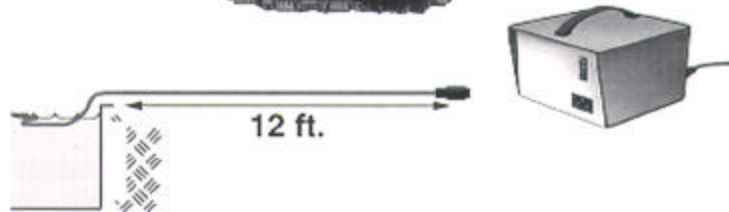

3. Plug the Power Supply into a GFCI grounded 115V outlet. *Never leave the Power Supply plugged in when the Aquabot is not in use.*

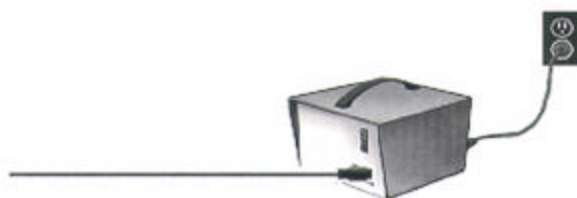

## That's it! Your Aquabot is ready to go!

Simply place the Aquabot into the pool and while holding the Floating Handle, gently rock it back and forth under the water to allow trapped air to escape. Then let go and it will settle to the pool bottom (make sure that the cleaner is resting level on the pool floor). Now, just switch on the Power Supply and watch the Aquabot clean your pool! *NOTE: Some Aquabot Models' Power Supplies are equipped with Timer Reset Switches which must be pressed each time you turn on the pool cleaner. The Reset Switch prevents the Aquabot from unintentional, "out of water" starts due to power surges or accidental pressing of the Power Supply On/Off Switch, which would damage the cleaner.*

**Warning!** A ground fault circuit interrupter (GFCI) must be installed to protect your electrical outlet and to prevent any possible electrical shock.

### Contents

Operating Features .....	2
Quick Start Instructions .....	3
Locking the Floating Handle .....	4
Locating the Power Supply .....	4
Setting The Timer .....	4
Remote Control Operation .....	5
Filter Bag Maintenance .....	5
Floation, Propeller and Cable Care .....	6
Brush and Drive Track Replacement .....	7
Drive Belt Replacement .....	8
Troubleshooting Guide .....	9-14
Using the E-Z Swivel Cord Detangler .....	15

# SETTING UP YOUR AQUABOT POOL CLEANER

## Floating Handle

The Floating Handle (Ref.# 1.1) is a floatation device that helps your Aquabot climb the walls, and acts as a guidance mechanism when the cleaner reaches the waterline directing it to circle the pool either clockwise or counter-clockwise. For proper operation of your pool cleaner, this Handle *must* be locked diagonally across the top of the cleaner's body.

**Important:** It is necessary to reverse the diagonal Handle direction after each use of the Aquabot to insure that the Floating Cable (Ref.# 1.19) does not become twisted or kinked and does not limit the cleaning coverage of the cleaner.

## To Lock The Aquabot's Handle:

1. Pull the right front Spring Lock (Ref.# 1.7) down and slide the Handle toward you, as far as it will go (Figure 5). Release the Spring Lock to secure the Handle in place.
2. Pull the left rear Spring Lock down and slide the Handle away from you as far as it will go. Release the Spring Lock to secure the Handle in place.

To reverse diagonal position of the Floating Handle, simply reverse the above procedure and lock the Handle diagonally across the Aquabot's body in the opposite direction (Figure 6).

Figure 5

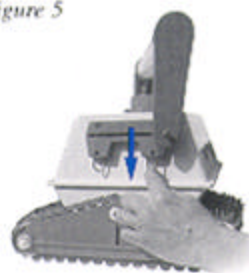

Handle Spring Lock

Figure 6



## Setting up the Power Supply

The Power Supply (Figure 4) should be placed in a sheltered area, *at least twelve (12) feet away from the pool*. While the Power Supply is *weather-resistant*, it should be placed in an elevated area where it will not accidentally be allowed to sit in puddles of water. For optimum cleaning performance locate the Power Supply at the mid-point on the longest side of your pool. This will allow the Aquabot to make the best use of its length of Floating Cable (Ref.# 3.1). If there is a 115V, three prong (grounded) socket outlet present, simply plug the Power Supply Cord (Ref.# 4.6 ) into this outlet. If necessary, a grounded extension cord may be used. *Ensure that the electric outlet is properly grounded*, as only then can the safety insulation of the Power Supply be effective.

Figure 7

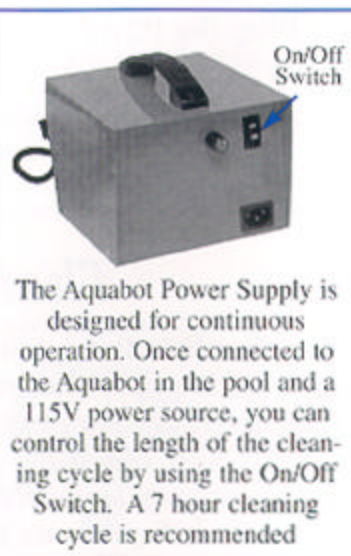
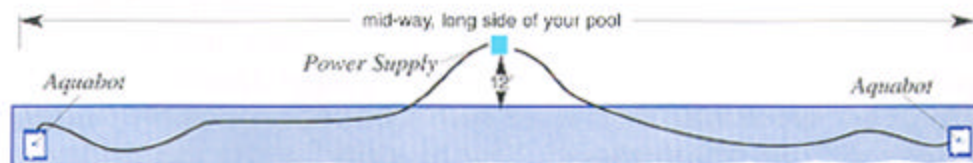

The Aquabot Power Supply is designed for continuous operation. Once connected to the Aquabot in the pool and a 115V power source, you can control the length of the cleaning cycle by using the On/Off Switch. A 7 hour cleaning cycle is recommended

## Setting The Aquabot Turbo Power Supply Timer

If your Cleaner has an Adjustable Timer you can set it for *Continuous* or *Timed* Cleaning



### Continuous Operation

1. Turn the Timer "OFF." Do this by turning the Timer Dial counterclockwise until you feel it "Click" into the "OFF" position.
2. Press the Main Power Rocker Switch to "ON." The pool cleaner will then be operating in "Continuous" mode and will stop cleaning the pool only when you turn the Main Power Switch to "OFF."

**NOTE:** The mode for operating your cleaner should be set after the cleaner has been placed in the pool, the Floating Cable from the cleaner has been attached to the Power Supply and the Power Supply has been plugged into a GFCI protected 115v electrical outlet.

### Timed Operation

1. Turn the Timer "OFF." Do this by turning the Timer Dial counterclockwise until you feel it "Click" into the "OFF" position.
2. Press the Main Power Rocker Switch to the "ON" position.
3. Turn the Timer Control clockwise to the desired cleaning time (1 to 7 hours).
4. Start the Cleaning Cycle by pressing the Reset Button. The cleaner will clean your pool for the length of time selected and then shut off *automatically*. To restart the cleaner you must repeat procedures 1 through 4.

*Remote Control Cleaners may be shipped with an External Timer which should be used like a common household appliance timer, with an automatic, internal 7 hour timer or with a Turbo style transformer (left) which includes the front mounted adjustable timer.*

## OPERATION OF MODELS WITH REMOTE CONTROL

*Aquabot Turbo SOLO - Aquabot Turbo Remote Control - Aquabot Plus Remote Control - Aquabot Ultra*

If your Aquabot has a Remote Control Feature you have the ability to direct it to various areas of the pool to pick up dirt and debris. It is best to operate your Wireless Controller within 100 feet of the Power Supply.

Figure 8

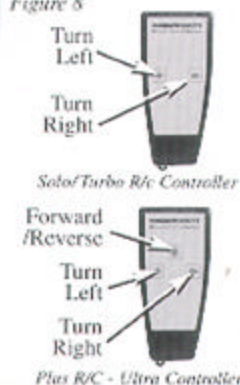

**Aquabot Turbo SOLO Remote Control (single piston Ref.# 1.18)** - Pressing either button on the Controller will make the cleaner to pivot on its piston and change direction for as long as the button is pressed.

**Aquabot Turbo Remote Control (twin piston Ref.# 1.18)** - Pressing the left or right button on the Controller will cause the cleaner to turn in that direction for as long as the button is pressed.

**Aquabot Plus Remote Control and Aquabot Ultra** do not change direction through the use of Pistons. These units have **Two Drive Motors (Ref.# 1.15)** and **Split Wheel Tubes (Ref.# 1.6)** and can be controlled to travel forward and in reverse as well as left and right.

*Special Note: All Remote Control Aquabots turn on their own periodically. This is a normal occurrence. The Aquabot is simply beginning a new, pre-programmed cleaning pattern. Once the Aquabot has made this turn you can re-direct it using your Controller.*

## Cleaning and Changing the Filter Bag

The Filter Bag's (Ref.# 1.16) holding capacity is large in comparison to other brands of independent pool cleaners, but far smaller than that of a pool's main filter. Additionally, the Aquabot's Filter Bag can filter out particles down to 20 times smaller than many main filters. This means that the fine particles such as algae and bacteria, invisible to the naked eye, which slip through the main filter and back into the pool to settle into the pores of the pool's surface, will be scrubbed loose and vacuumed up by the Aquabot and retained in its Filter Bag.

When the Filter Bag becomes saturated with debris the flow of water through it becomes restricted and suction is reduced. Strong water flow is required to force the Aquabot against the wall when climbing. A dirty Filter Bag also weighs the Aquabot down, making it hard for the cleaner to climb due to the added weight and reduced water flow. **If the cleaner does not climb and reach the waterline to move left and right it will not cover and clean the entire pool. Therefore, it is important to clean the Filter Bag thoroughly so that the fine particles that get trapped within the fibers of the Filter Bag are removed.**

### To Clean The Filter Bag:

1. Unplug the Power Supply (Figure 4).
2. If the Aquabot is in the pool, gently pull it toward you using the Floating Cable (Ref.# 1.19) until the Floating Handle (Ref.# 1.1) is within reach. Use the Floating Handle (*not the Floating Cable*) to slowly pull the cleaner out of the pool after allowing most of the water to drain from the cleaner.
3. Lay the Aquabot on its back on a soft surface to avoid scratching it. Gently pull on the Lock Tab (Ref.# 1.21) on one end of the Bottom Lid (Ref.# 2.1) freeing one end of the Bottom Lid (Figure 9 inset). Repeat this procedure on the other end and remove the Bottom Lid Assembly (Ref. 1.20).
4. Remove the Filter Bag (Ref # 1.16) from the "W" Frames (Ref.# 2.2), turn it inside out and wash off all the dirt with a garden hose or in a bucket. Squeeze the Bag gently until the rinse water is clear. If necessary machine wash the Bag using only cold water with **NO DETERGENT**. You may re-install the bag immediately or allow it to air dry.
5. Re-install the Bag on the "W" frames of the Bottom Lid Assembly, making sure that the "felt" (soft) side is facing in. To ensure a proper fit of the Filter Bag onto the Bottom Lid Assembly, locate the small Label near the Filter Bag's elastic bottom. Position the Filter Bag so that the small Label is at the center of either long side of the Bottom Lid. Then pull the elastic bottom over each Wire and slide the Filter Bag down along the Wires until the Bag reaches the Bottom Lid. At that point the Filter Bag's elastic bottom should be stretched over the plastic ridges located at opposing ends of the short sides of the Bottom Lid. This holds the Filter Bag in place. Press down on top of the Filter Bag where each of the four "U" shaped slots on the Wire Frame are located. This will pull the Filter Bag corners to the corners of the Wire Frame (Figure 10).
6. Re-install the Bottom Lid Assembly into the bottom of the Aquabot. Be sure that the Filter Bag's fabric is not interfering with the locking of the Lock Tabs.

Figure 9

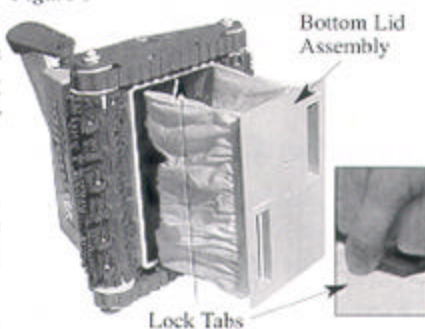
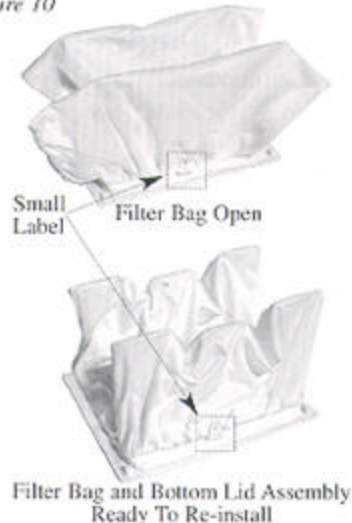

Figure 10



## Floatation

The Aquabot is a universal pool cleaner which must perform under varying chemical and temperature conditions in your pool. The Aquabot offers the best possible performance when it is virtually weightless in your pool. Therefore careful balancing of its weight is important.

Generally, a new Aquabot is very light when used for the first time. Careful removal of air trapped in the housing is critical. Typically, additional floatation is not required on start-up.

Most pool conditions allow your Aquabot to climb the pool walls and stairs effortlessly up to the waterline. However, in some instances the pool environment (e.g., temperature, chemicals, water, etc.) may offset your cleaner's natural buoyancy. Therefore, 3 floatation devices have been included in the packaging with your new Aquabot: an "H"-Float (Ref.# 2.3) and 2 "Side Pocket" Floats (Ref.# 2.4) to assist its buoyancy.

To Add Floatation: (Figure 11)

1. Remove the 2 Screws from the "H"-Float. Then, place the "H"-Float, foam-side down, against the inside base of the Bottom Lid Assembly (Ref.# 1.20). Secure the "H"-Float with the two Screws provided by fastening them in from the outside of the Bottom Lid Assembly. This should provide adequate buoyancy.
2. Should your Aquabot require more floatation, then add the 2 remaining Pocket Floats to see if that is sufficient. Pocket Floats do not require any screws or glue. Simply place them into the open rectangular areas situated beside Intake Valves Housings (Ref.# 2.5).

### Important Note:

Temperature and chemical composition changes can greatly affect the buoyancy of your Aquabot. Therefore, if you have previously installed floatation devices in your Aquabot to assist its buoyancy, it may be necessary to remove the devices one-by-one until proper buoyancy is restored.

Figure 11

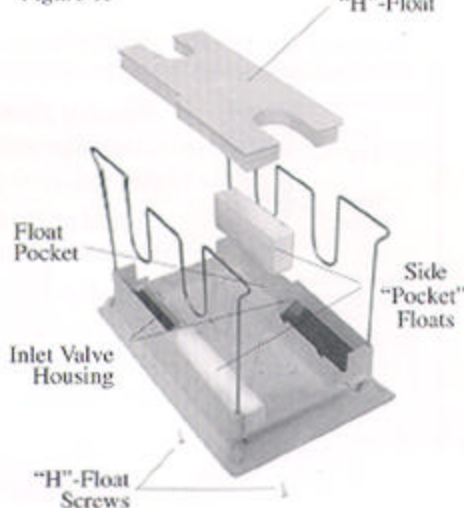
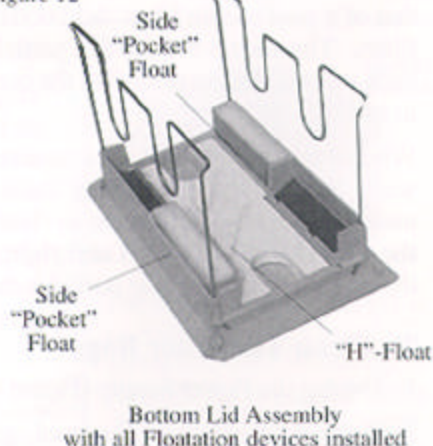

Figure 12



## Propeller Care (Figures 13 A&B)

It is a good practice to inspect the Propeller (Ref.# 1.3) once or twice per season to check for obstructions which may reduce water flow and thus vacuuming ability.

First, unplug the Aquabot from the Power Supply (Figure 4). Then, use a screwdriver to remove the 4 Screws which secure the Outlet Top (Ref.# 1.2) to the Body (Figure 13A). Inspect the Propeller for clogs: hair, twigs, or other debris, which may keep it from spinning freely (Figure 13B). Remove any accumulated material and replace the Outlet Top. Be careful not to over-tighten the Screws and "strip" the Screw Holes when re-assembling.

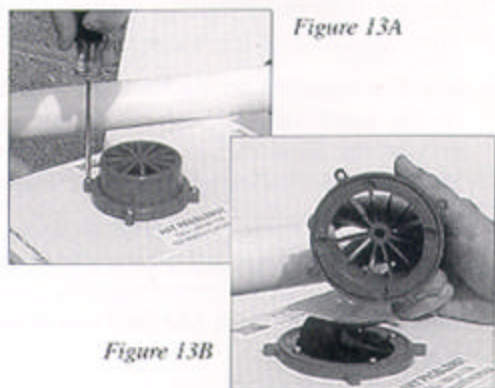

## Cable Care

The Floating Cable (Ref.# 3.1) may become twisted after a period of time in use. To correct this condition, simply lock the Floating Handle (Ref.# 1.1) on the top of the Aquabot in the opposite diagonal direction (See Figures 5 & 6, Pg. 4). The Aquabot will now travel in the opposite direction along the waterline while cleaning your pool and the Floating Cable will uncoil. To manually untangle the cable using the EZ-Swivel (Ref.# 3.5) See Pg. 15. You should also check the Floating Cable periodically for external damage. Continual rubbing against sharp or rough surfaces may abrade the Floating Cable resulting in damage and possible short-circuiting of the Aquabot.



**Never lift your Aquabot out of the pool using the Floating Cable.** You may use the Floating Cable to pull the Aquabot to the side of the pool, but always use the Floating Handle to remove it from the pool. Pulling on the Floating Cable to remove the Aquabot from the pool will result in internal connections being broken and severe damage being caused to your Aquabot.

## Scrubbing Brushes

The Aquabot's Brushes (Ref.# 1.4 / 1.4.1) provide traction and the ability to loosen debris. It is important that the Brushes are not worn otherwise the Aquabot may lose the ability to climb to the waterline and move sideways to reach other areas of the pool. The Rubber Brushes that come standard on most models will function well on most any surface (including concrete, plaster, gunite, vinyl, fiberglass, pebble tech, etc.).

*Note: Rubber Brushes begin to stiffen in water less than 70°F which lessens their ability to climb pool walls.*

## Changing Scrubbing Brushes

Eventually you will need to change the Brushes on your Aquabot. When they need replacement will depend upon how often you use your Aquabot and upon the conditions of your pool. High chemical concentrations and rough surfaces will cause faster Brush wear. We recommend that you inspect Brushes frequently to check for excessive wear.

### To Change Rubber Brushes:

1. Remove the old Brushes by cutting the Fastening Tabs with a pair of scissors (Aquabot) or removing the Metal Rod (Aquabot Turbo).
2. Wrap the new Super Brush around the Wheel Tube.
3. Join the ends of the replacement Super Brush using the Metal Rod supplied in the package. Slide the Rod through the Tabs molded into the ends of the Brush (Figure 14). Make sure that the Rod is inserted through every Tab.

### To Change Foam Brushes:

1. Remove the old brushes.
2. Wrap the new brushes around the wheel tube.
3. Snap the tabs with the holes over the corresponding buttons found on the opposite end of the plastic brush grid (Figure 15). Make sure that they fit snugly. Repeat this process with all of the tabs and buttons.

## Drive Tracks

Drive Tracks (Ref.# 1.5 / 1.5.1) may become worn over time. Should this happen it will affect the Aquabot's ability to climb stairs and climb over obstacles in your pool. Worn Tracks may also have an effect on the Aquabot's cleaning pattern, impeding its ability to cover the entire pool. If you inspect the Tracks and find that they are stretched, loose or "flat-spotted" due to wear, it is time to replace them (*NOTE: When ordering replacement tracks be sure to specify the type of track you are replacing ie. Standard or "G" Tracks*).

1. Unplug the Aquabot from the Power Supply (Figure 4) and remove it from the pool.
2. Place the Aquabot on its side, on a soft surface which will not scratch the body's finish.
3. With your thumbs pushing against the Side Plate (Ref.# 1.13), hook your fingers around the Track and pull it toward the Side Plate (Figure 16). When you get the Drive Track over the "lip" of the Side Plate, hold it there with one hand, and with the other hand, grip the Wheel Tube (Ref.# 1.6) and rotate it toward you until the Track "walks" over the Side Plate. Continue this until the Drive Track is free.
4. To mount the new Track, hook it around one Wheel Tube end and pull it toward you as you guide it inside the bottom of the Side Plate (Figure 17).
5. Push inward on the Drive Track and force it over the edge of the Side Plate (Figure 17 insert). Rotate the Wheel Tube away from you until the Drive Track seats itself properly.
6. Repeat steps 1 through 5 with the Drive Track on the other side of the Aquabot. Always replace both Tracks at the same time. Replacing only one will adversely effect the Aquabot's cleaning pattern.

Figure 14

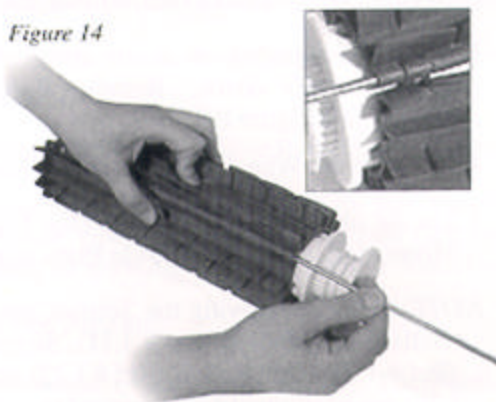

Figure 15



Figure 16

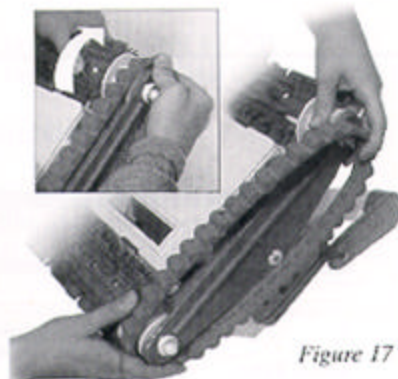

Figure 17

## Changing The Drive Belts

After a number of months or years, depending on usage, the Drive Belts (Ref.# 1.8) [2 located behind the Side Plate (Ref.# 1.13) on the Drive Motor (Ref.# 1.15) side of the Aquabot®] may begin to stretch. To maintain optimum performance these will require replacement.

1. Unplug the Aquabot from the Power Supply (Figure 4).
2. Remove Drive Tracks (Ref.# 1.5 or 1.5.1)(Figure 18).
3. Place the Aquabot on a non-abrasive surface and turn cleaner upside down. Remove Bottom Lid Assembly (Ref.# 1.20)(Figure 19).
4. Remove the Wheel Tube Retaining Rings (Ref.# 1.12).
5. Locate and remove 4 Screws (see Figure 20) on Drive Motor side, which holds Side Plate in place.

**NOTE:** Before removing the Screws, notice how the Drive Belts, Drive Pulley (Ref.# 1.11), Stepped Sleeve Rollers (Ref.# 1.9), Small Rollers (Ref.# 1.22) and Bushings (Ref.# 1.10) are positioned for re-assembly.

6. Remove old Belts and replace them with new Drive Belts, being careful to properly position the replacements. One Belt from the Drive Pulley to the Front Wheel Tube (Ref.# 1.6), one from the Drive Pulley to the Rear Wheel Tube. The Belts must press against the thicker side of the Stepped Sleeve Rollers for proper tension (see Figure 21B).

7. To re-assemble, reverse steps 6 through 2.

\* The Aquabot Plus Remote Control and Aquabot Ultra have a total of 4 Drive Belts, 2 located behind each Side Plate.

Figure 18



Figure 19

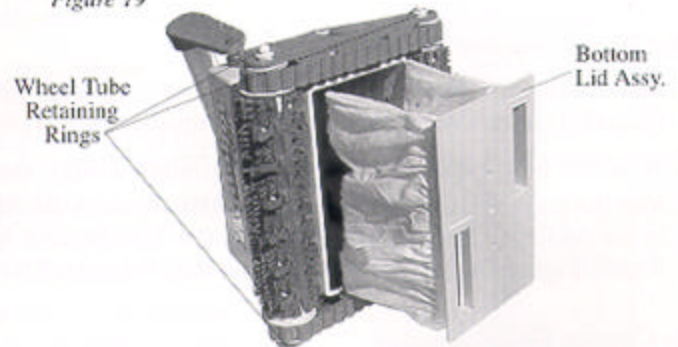

Figure 20

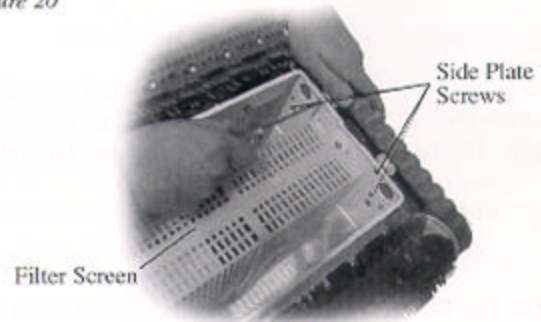

Figure 21A

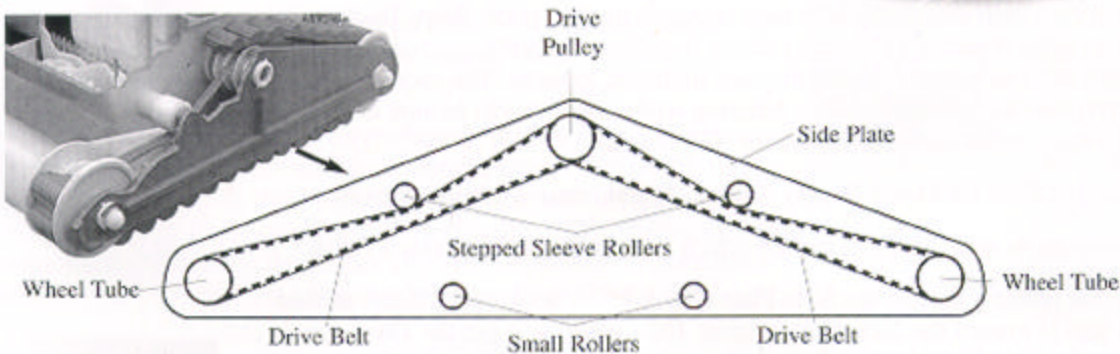

Figure 21 B

### Belt Alignment - Overhead View

