

# Parts Breakdown for the Esther Williams Festival & Fairfield (GRAY)

Click the image and get redicted to that part.

**Top Seat (Gray)**  
F10317-36

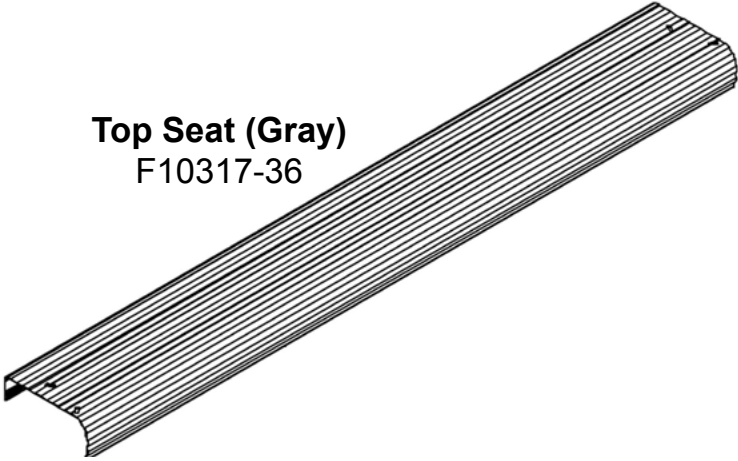

**Front Coping Cover (Gray)**  
T3600-88



**Rear Coping Cover (Gray)**  
T3887-88



**Captive Nut Kit**

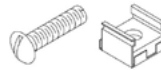

**Cover Plug**  
T3961-33



**Bead Receiver (Rolled Wall)**

15' Round F9279  
18' Round F9280  
21' Round F9281  
24' - 30' Round F9282

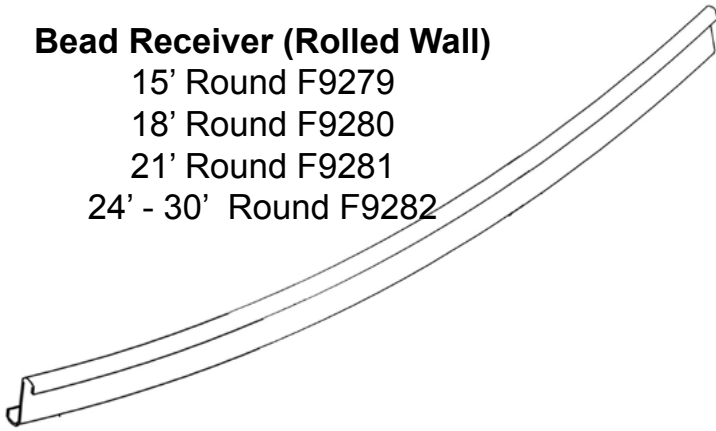

**Rolled Wall**

email

Parts@teddybearpools.com

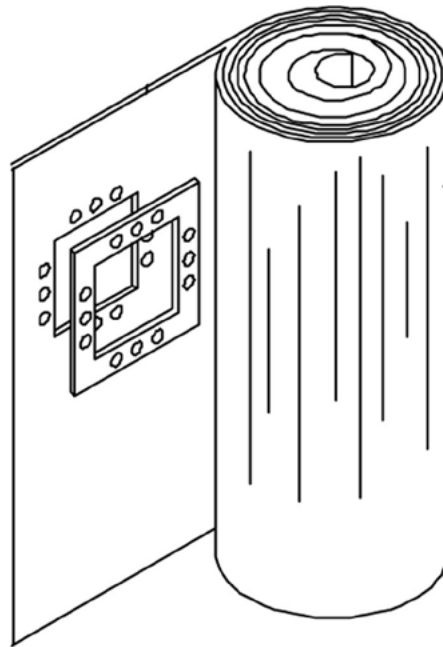

**Upright (Gray) 52"**  
F9338-36

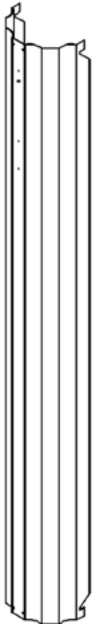

**Wall Strap**  
F8559-00-02

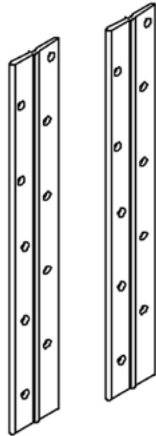

**Hayward Skimmer Kit**  
SP1091LX

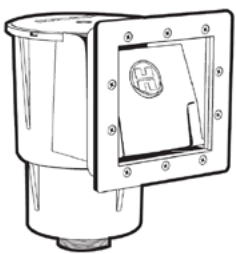

**Wall Channels**  
Click for Sizes

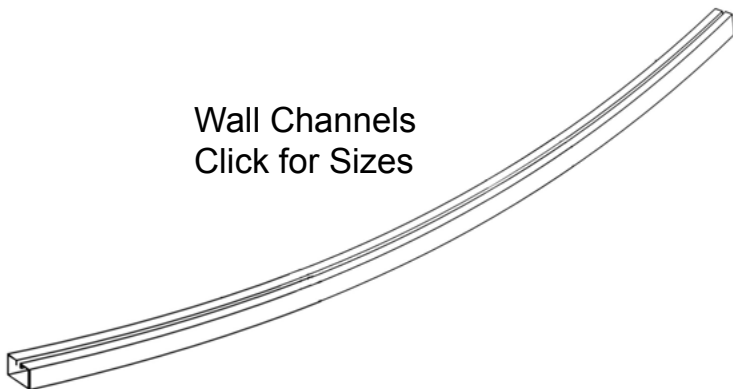

**Bottom/Top Plate**  
F9728-00

